

Sewer/Water Utility - Trace Wire Specification

Materials

General

All trace wire and trace wire products shall be domestically manufactured in the U.S.A.

All trace wire shall have HDPE insulation intended for direct bury, color coated per APWA standard for the specific utility being marked.

Trace wire

- **Open Trench** - Trace wire shall be #12 AWG Copper Clad Steel, High Strength with minimum 450 lb. break load, with minimum 30 mil HDPE insulation thickness.
- **Directional Drilling/Boring** - Trace wire shall be #12 AWG Copper Clad Steel, Extra High Strength with minimum 1,150 lb. break load, with minimum 30 mil HDPE insulation thickness.
- **Trace wire – Pipe Bursting/Slip Lining** - Trace wire shall be 7 x 7 Stranded Copper Clad Steel, Extreme Strength with 4,700 lb. break load, with minimum 50 ml HDPE insulation thickness.

Connectors

- All mainline trace wires must be interconnected in intersections, at mainline tees and mainline crosses. At tees, the three wires shall be joined using a single 3-way lockable connector. At Crosses, the four wires shall be joined using a 4-way connector. Use of two 3-way connectors with a short jumper wire between them is an acceptable alternative.
- **Direct bury wire connectors** – shall include 3-way lockable connectors and mainline to lateral lug connectors specifically manufactured for use in underground trace wire installation. Connectors shall be dielectric silicon filled to seal out moisture and corrosion, and shall be installed in a manner so as to prevent any uninsulated wire exposure.
- Non locking friction fit, twist on or taped connectors are prohibited.

Termination/Access

- All trace wire termination points must utilize an approved trace wire access box (above ground access box or grade level/in-ground access box as applicable), specifically manufactured for this purpose.
- All grade level/in-ground access boxes shall be appropriately identified with “sewer” or “water” cast into the cap and be color coded.
- A minimum of 2 ft. of excess/slack wire is required in all trace wire access boxes after meeting final elevation.
- All trace wire access boxes must include a manually interruptible conductive/connective link between the terminal(s) for the trace wire connection and the terminal for the grounding anode wire connection.
- Grounding anode wire shall be connected to the identified (or bottom) terminal on all access boxes.

Sewer/Water Utility - Trace Wire Specification

- **Service Laterals on public property** - Trace wire must terminate at an approved grade level/in-ground trace wire access box, located at the edge of the road right-of-way, and out of the roadway.
- **Service Laterals on private property** - Trace wire must terminate at an approved above-ground trace wire access box, affixed to the building exterior directly above where the utility enters the building, at an elevation not greater than 5 vertical feet above finished grade, or terminate at an approved grade level/in-ground trace wire access box, located within 2 linear feet of the building being served by the utility.
- **Hydrants** – Trace wire must terminate at an approved above-ground trace wire access box, properly affixed to the hydrant grade flange. (affixing with tape or plastic ties shall not be acceptable)
- **Long-runs, in excess of 500 linear feet without service laterals or hydrants** - Trace wire access must be provided utilizing an approved grade level/in-ground trace wire access box, located at the edge of the road right-of-way, and out of the roadway. The grade level/in-ground trace wire access box shall be delineated using a minimum 48" polyethylene marker post, color coded per APWA standard for the specific utility being marked.

Grounding

- Trace wire must be properly grounded at all dead ends/stubs
- Grounding of trace wire shall be achieved by use of a drive-in magnesium grounding anode rod with a minimum of 20ft of #14 red HDPE insulated copper clad steel wire connected to anode (minimum 0.5 lb.) specifically manufactured for this purpose, and buried at the same elevation as the utility.
- When grounding the trace wire at dead ends/stubs, the grounding anode shall be installed in a direction 180 degrees opposite of the trace wire, at the maximum possible distance.
- When grounding the trace wire in areas where the trace wire is continuous and neither the mainline trace wire or the grounding anode wire will be terminated at/above grade, install grounding anode directly beneath and in-line with the trace wire. Do not coil excess wire from grounding anode. In this installation method, the grounding anode wire shall be trimmed to an appropriate length before connecting to trace wire with a mainline to lateral lug connector.
- Where the anode wire will be connected to a trace wire access box, a minimum of 2 ft. of excess/slack wire is required after meeting final elevation.

Installation

General

- Trace wire installation shall be performed in such a manner that allows proper access for connection of line tracing equipment, proper locating of wire without loss or deterioration of low frequency (512Hz) signal for distances in excess of 1,000 linear feet, and without distortion of signal caused by multiple wires being installed in close proximity to one another.
- Trace wire systems must be installed as a single continuous wire, except where using approved connectors. No looping or coiling of wire is allowed.

Sewer/Water Utility - Trace Wire Specification

- Any damage occurring during installation of the trace wire must be immediately repaired by removing the damaged wire, and installing a new section of wire with approved connectors. Taping and/or spray coating shall not be allowed.
- Trace wire shall be installed at the bottom half of the pipe and secured (taped/tied) at 5' intervals.
- Trace wire must be properly grounded as specified.
- Trace wire on all service laterals/stubs must terminate at an approved trace wire access box located directly above the utility, at the edge of the road right-of-way, but out of the roadway. (See Trace wire Termination/Access)
- At all mainline dead-ends, trace wire shall go to ground using an approved connection to a drive-in magnesium grounding anode rod, buried at the same depth as the trace wire. (See Grounding)
- Mainline trace wire shall not be connected to existing conductive pipes. Treat as a mainline dead-end, ground using an approved waterproof connection to a grounding anode buried at the same depth as the trace wire.
- All service lateral trace wires shall be a single wire, connected to the mainline trace wire using a mainline to lateral lug connector, installed without cutting/splicing the mainline trace wire.
- In occurrences where an existing trace wire is encountered on an existing utility that is being extended or tied into, the new trace wire and existing trace wire shall be connected using approved splice connectors, and shall be properly grounded at the splice location as specified.

Sanitary Sewer System

- A mainline trace wire must be installed, with all service lateral trace wires properly connected to the mainline trace wire, to ensure full tracing/locating capabilities from a single connection point.
- Lay mainline trace wire continuously, by-passing around the outside of manholes/structures on the North or East side.
- Trace wire on all sanitary service laterals must terminate at an approved trace wire access box color coded green and located directly above the service lateral at the edge of road right of way.

Water System

- A mainline trace wire must be installed, with all service lateral trace wires properly connected to the mainline trace wire, to ensure full tracing/locating capabilities from a single connection point.
- Lay mainline trace wire continuously, by-passing around the outside of valves and fittings on the North or East side.
- Trace wire on all water service laterals must terminate at an approved trace wire access box color coded blue and located directly above the service lateral at the edge of road right of way.
- Above-ground tracer wire access boxes will be installed on all fire hydrants.
- All conductive and non-conductive service lines shall include tracer wire.

Sewer/Water Utility - Trace Wire Specification

Storm Sewer System

This section shall be included at the discretion of the facility owner.

- If the storm sewer system includes service laterals for connection of private drains and tile lines, it shall be specified the same as a sanitary sewer application.
- Lay mainline trace wire continuously, by-passing around the outside of manholes/structure on the North or East side.

Prohibited Products and Methods

The following products and methods shall not be allowed or acceptable

- Uninsulated trace wire
- Trace wire insulations other than HDPE
- Trace wires not domestically manufactured
- Non locking, friction fit, twist on or taped connectors
- Brass or copper ground rods
- Wire connections utilizing taping or spray-on waterproofing
- Looped wire or continuous wire installations, that has multiple wires laid side-by-side or in close proximity to one another
- Trace wire wrapped around the corresponding utility
- Brass fittings with trace wire connection lugs
- Wire terminations within the roadway, i.e. in valve boxes, cleanouts, manholes, etc.
- Connecting trace wire to existing conductive utilities

Testing

All new trace wire installations shall be located using typical low frequency (512Hz) line tracing equipment, witnessed by the contractor, engineer and facility owner as applicable, prior to acceptance of ownership.

This verification shall be performed upon completion of rough grading and again prior to final acceptance of the project.

Continuity testing in lieu of actual line tracing shall not be accepted.

Sewer/Water Utility - Trace Wire Specification

Products

The following products have been deemed acceptable and appropriate. These products are a guide only to help you choose the correct applications for your tracer wire project.

- Copper clad Steel (CCS) trace wire
 - Open Trench – Copperhead #12 High Strength part # 1230-HS
 - Directional Drilling/Boring - Copperhead Extra High Strength part # 1245*EHS
 - Pipe Bursting/Slip Lining – Copperhead SoloShot Extreme Strength 7 x 7 Stranded part # PBX-50
- Connectors
 - Copperhead 3-way locking connector part # LSC1230*
 - DryConn 3- way Direct Bury Lug: Copperhead Part # 3WB-01
- Termination/Access
 - Non-Roadway access boxes applications: Trace wire access boxes Grade level Copperhead adjustable lite duty Part # LD14*TP
 - Concrete / Driveway access box applications: Trace wire access boxes Grade level Copperhead Part # CD14*TP 14”
 - Fire hydrant trace wire access box applications: Above ground two terminal with 1” conduit. Copperhead part # T3-75-F (Cobra T3 Test Station, denoting “F” includes mounting flange)
- Grounding
 - Drive in Magnesium Anode: Copperhead Part # ANO-1005 (1.5 lb)

Manufacture product options:

The information provided by Copperhead Industries gives you product options to help you choose the correct wire – termination/access points – connectors and grounding products. Other manufactures provide these products; this information is only a guide.

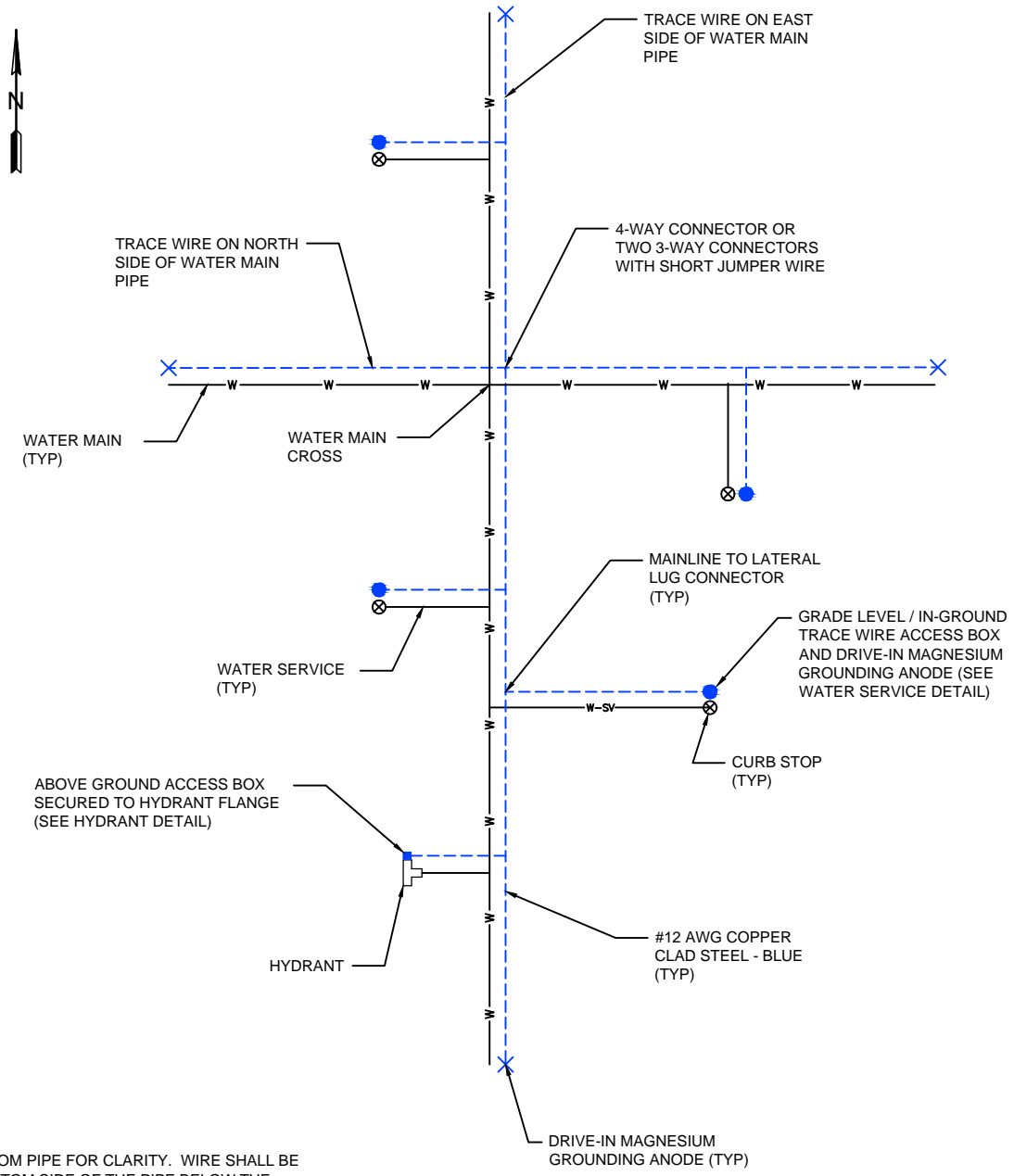

NOTES:
 1. WIRE SHOWN AWAY FROM PIPE FOR CLARITY. WIRE SHALL BE INSTALLED ON THE BOTTOM SIDE OF THE PIPE BELOW THE SPRING LINE. THE WIRE SHALL BE FASTENED TO THE PIPE WITH TAPE OR PLASTIC TIES AT 5' INTERVALS.

TRACE WIRE PLAN (WATER)
 NO SCALE



MINNESOTA RURAL WATER ASSOCIATION
 STANDARD DETAIL

TRACE WIRE
 SAMPLE WATER PLAN

May 28, 2014

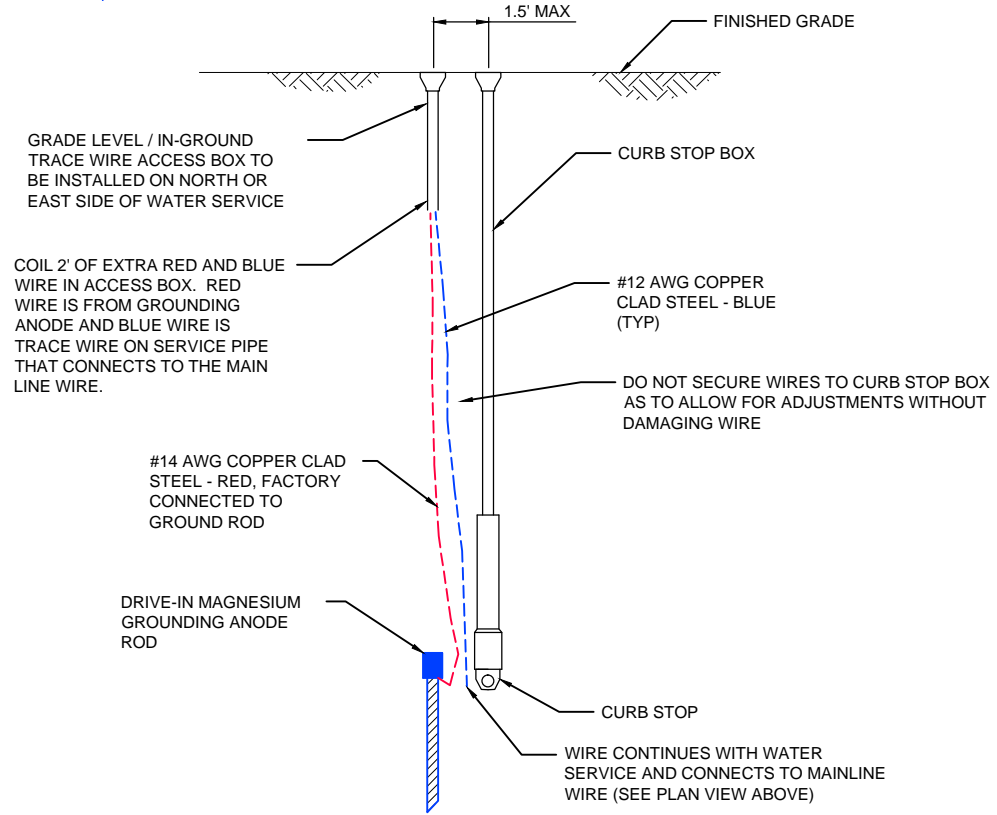
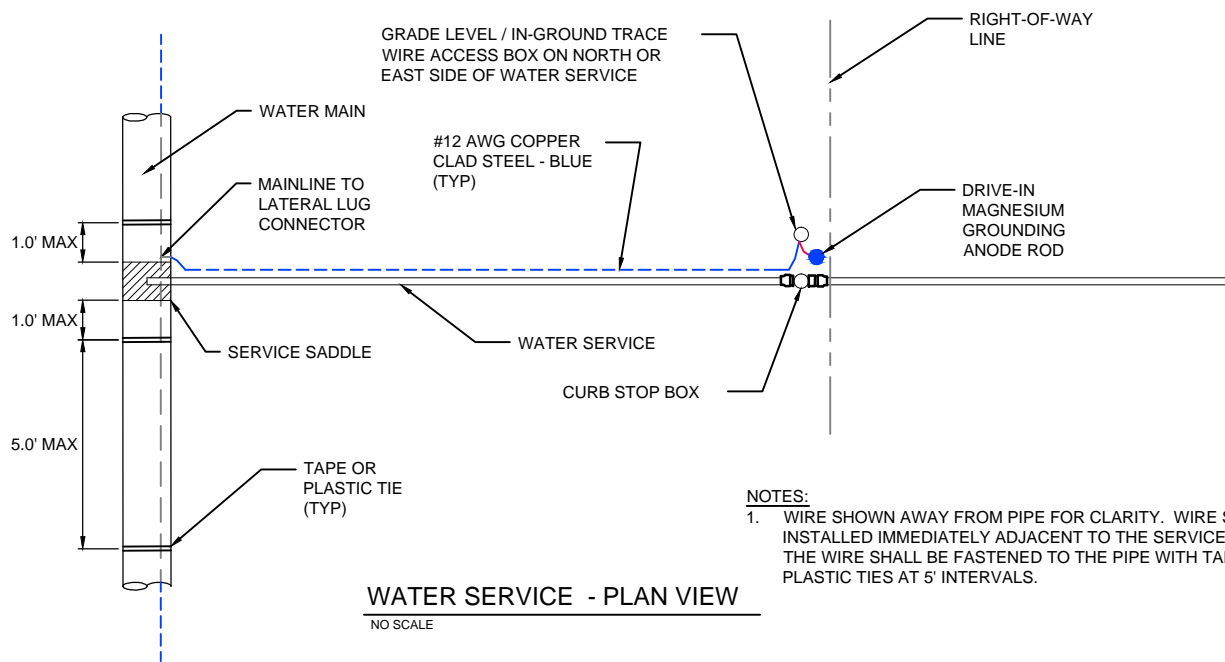

MINNESOTA RURAL WATER ASSOCIATION
 STANDARD DETAIL

TRACE WIRE
 WATER SERVICE DETAIL

May 28, 2014

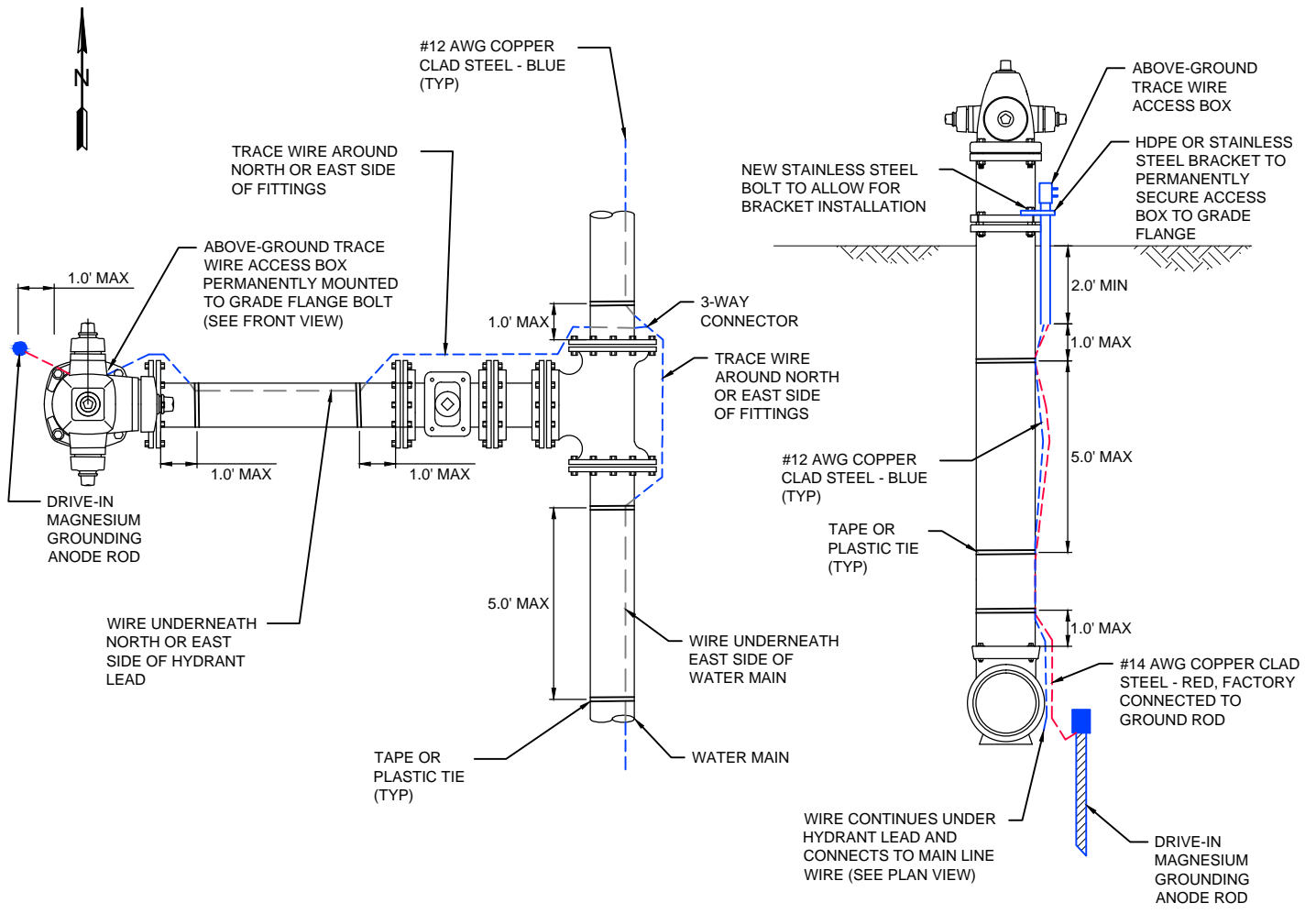

HYDRANT - PLAN VIEW

NO SCALE

HYDRANT - SECTION VIEW

NO SCALE



MINNESOTA RURAL WATER ASSOCIATION
STANDARD DETAIL

TRACE WIRE
HYDRANT DETAIL

May 28, 2014

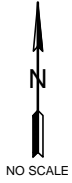

NO SCALE

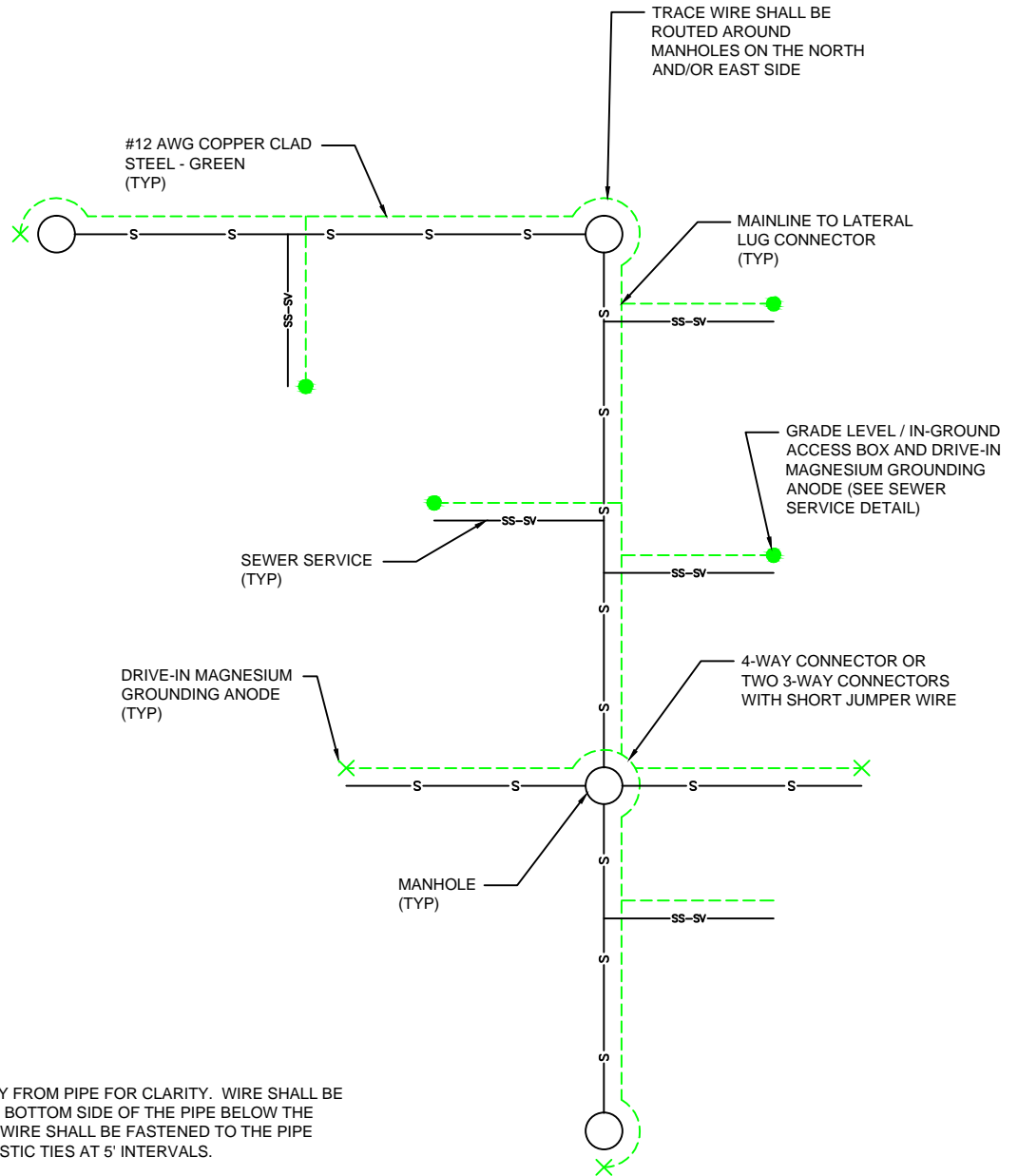

NOTES:

1. WIRE SHOWN AWAY FROM PIPE FOR CLARITY. WIRE SHALL BE INSTALLED ON THE BOTTOM SIDE OF THE PIPE BELOW THE SPRING LINE. THE WIRE SHALL BE FASTENED TO THE PIPE WITH TAPE OR PLASTIC TIES AT 5' INTERVALS.

TRACE WIRE PLAN (SEWER)

NO SCALE



MINNESOTA RURAL WATER ASSOCIATION
STANDARD DETAIL

TRACE WIRE
SAMPLE SEWER PLAN

May 28, 2014

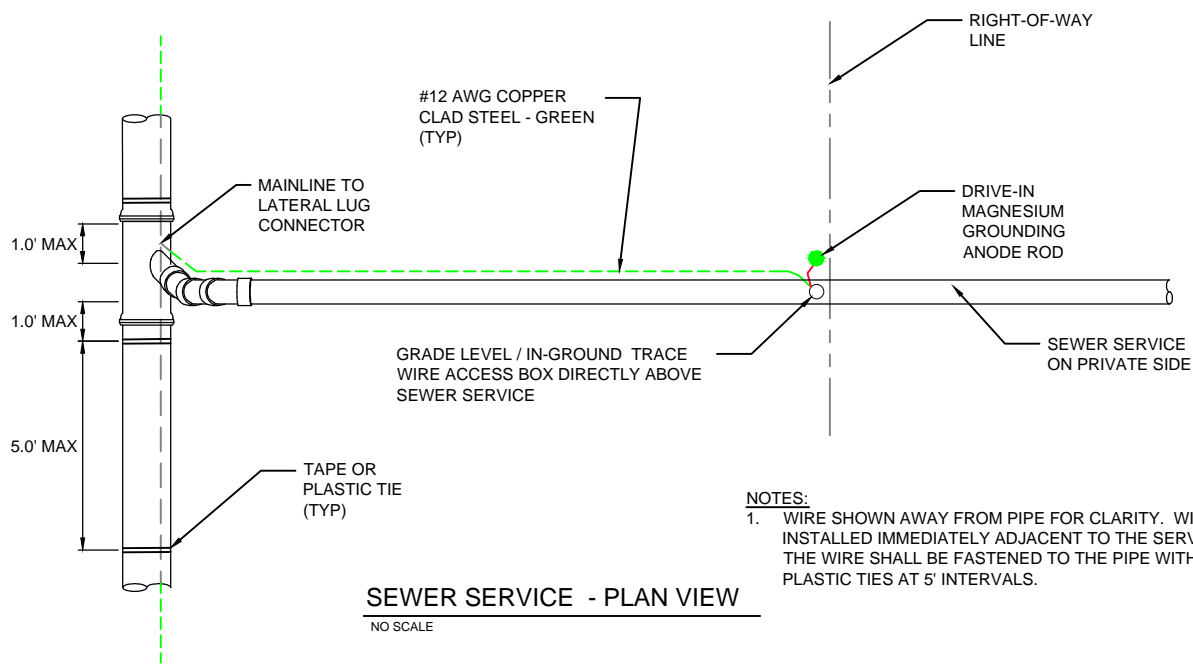

SEWER SERVICE - PLAN VIEW

NO SCALE

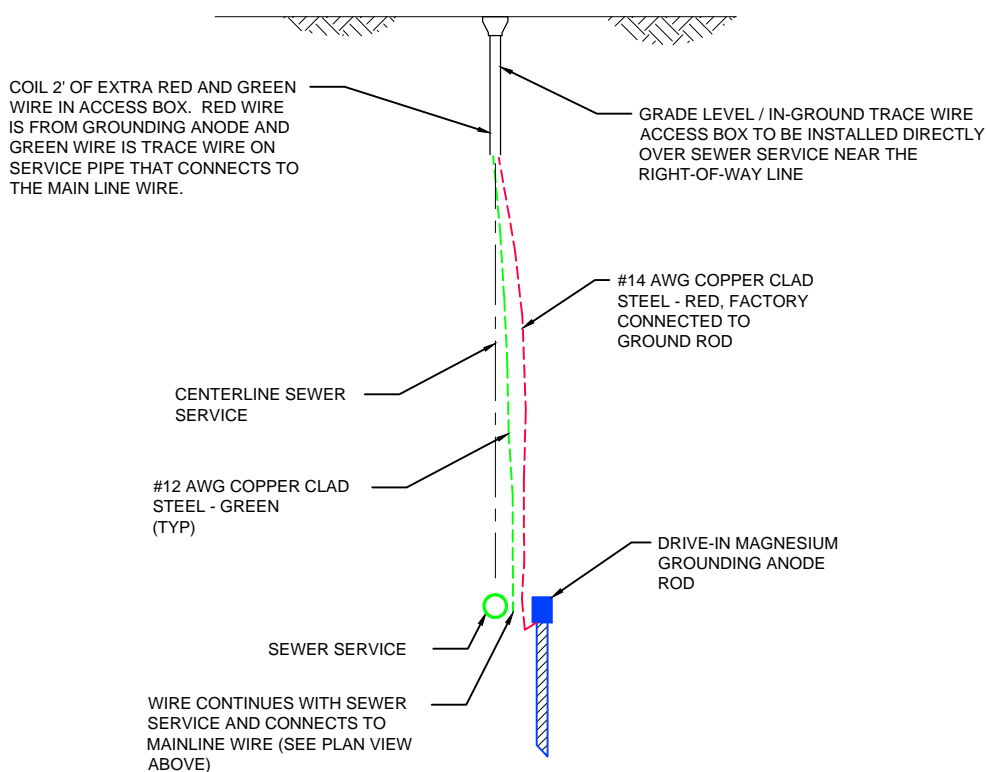

SEWER SERVICE - SECTION VIEW

NO SCALE



MINNESOTA RURAL WATER ASSOCIATION
STANDARD DETAIL

TRACE WIRE
SEWER SERVICE DETAIL

May 28, 2014

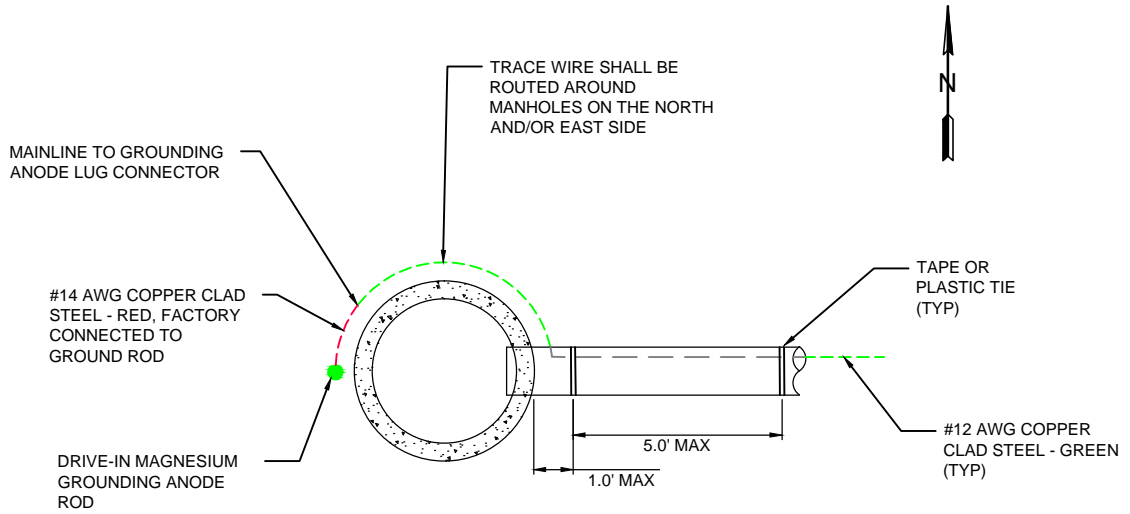

SEWER MANHOLE - PLAN VIEW

NO SCALE

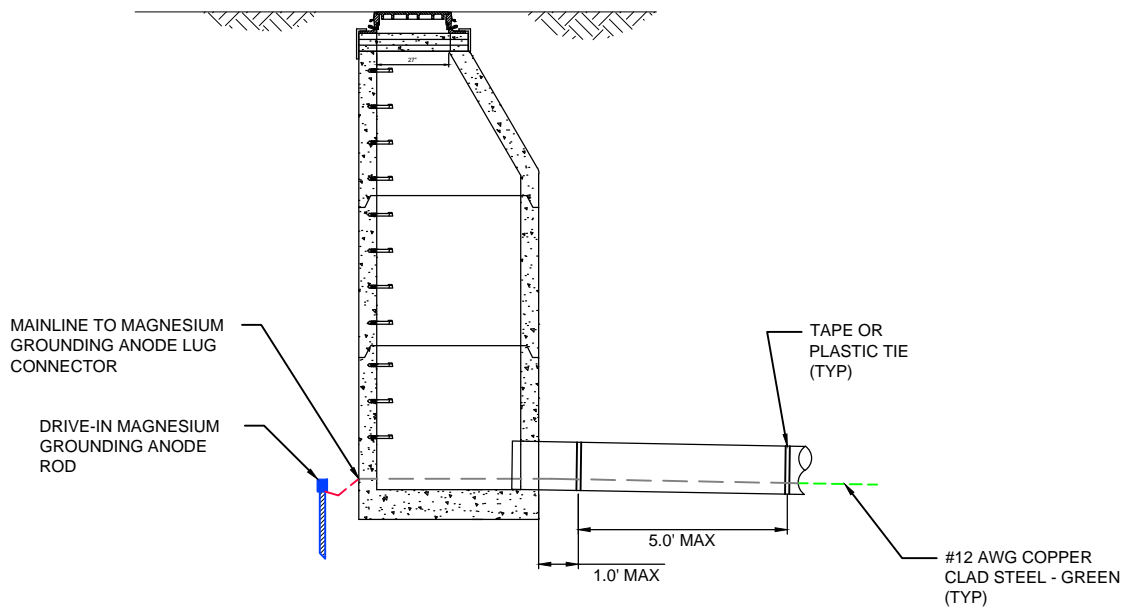

SEWER MANHOLE - SECTION VIEW

NO SCALE



MINNESOTA RURAL WATER ASSOCIATION
STANDARD DETAIL

TRACE WIRE
SEWER MANHOLE DETAIL

May 28, 2014